

MURO SPONDA V250R

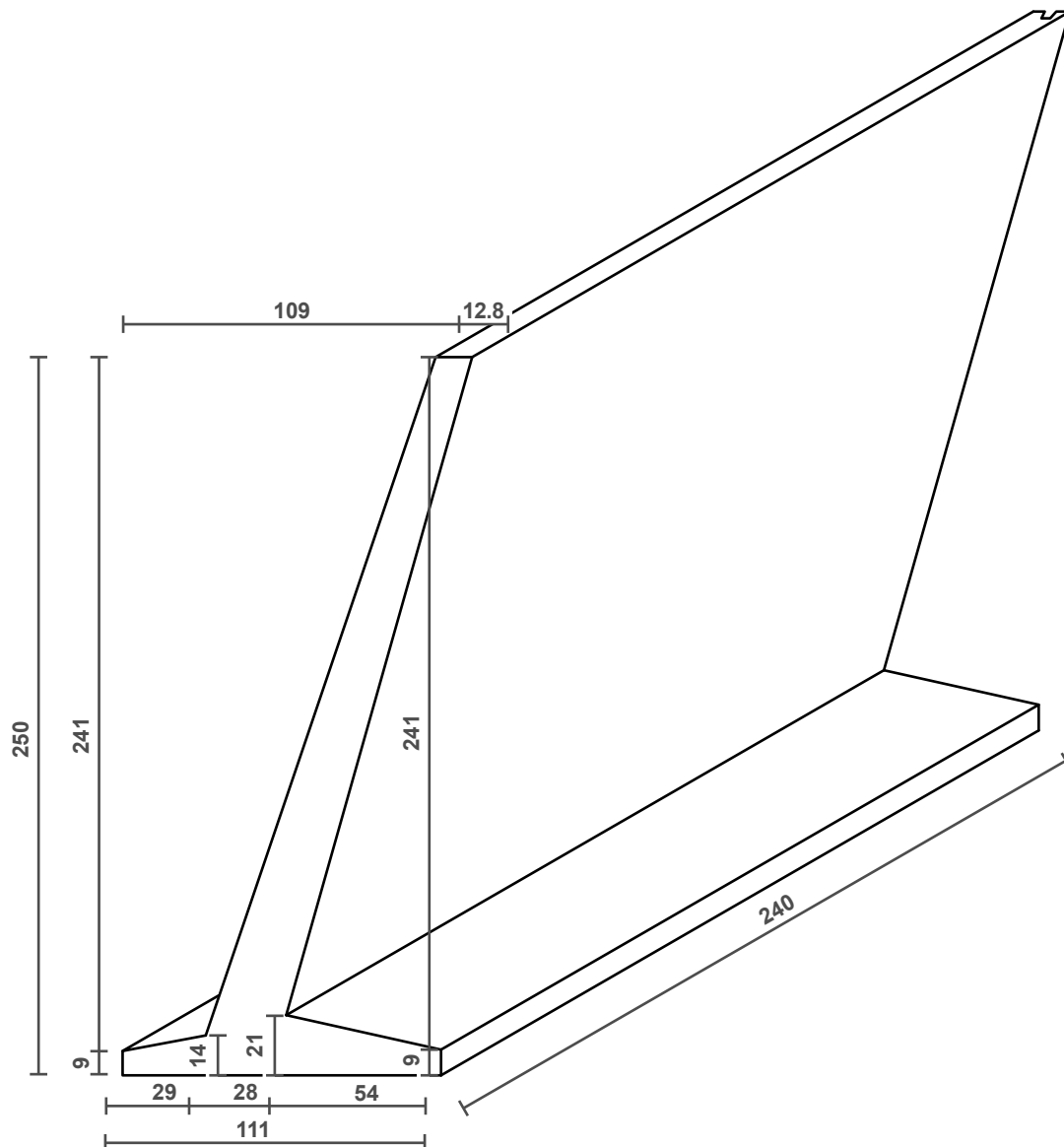

Dimensione elemento
1,11 x 2,40 m H. 2,50 m

Peso elemento
50 q.li