

MURO SPONDA V150R

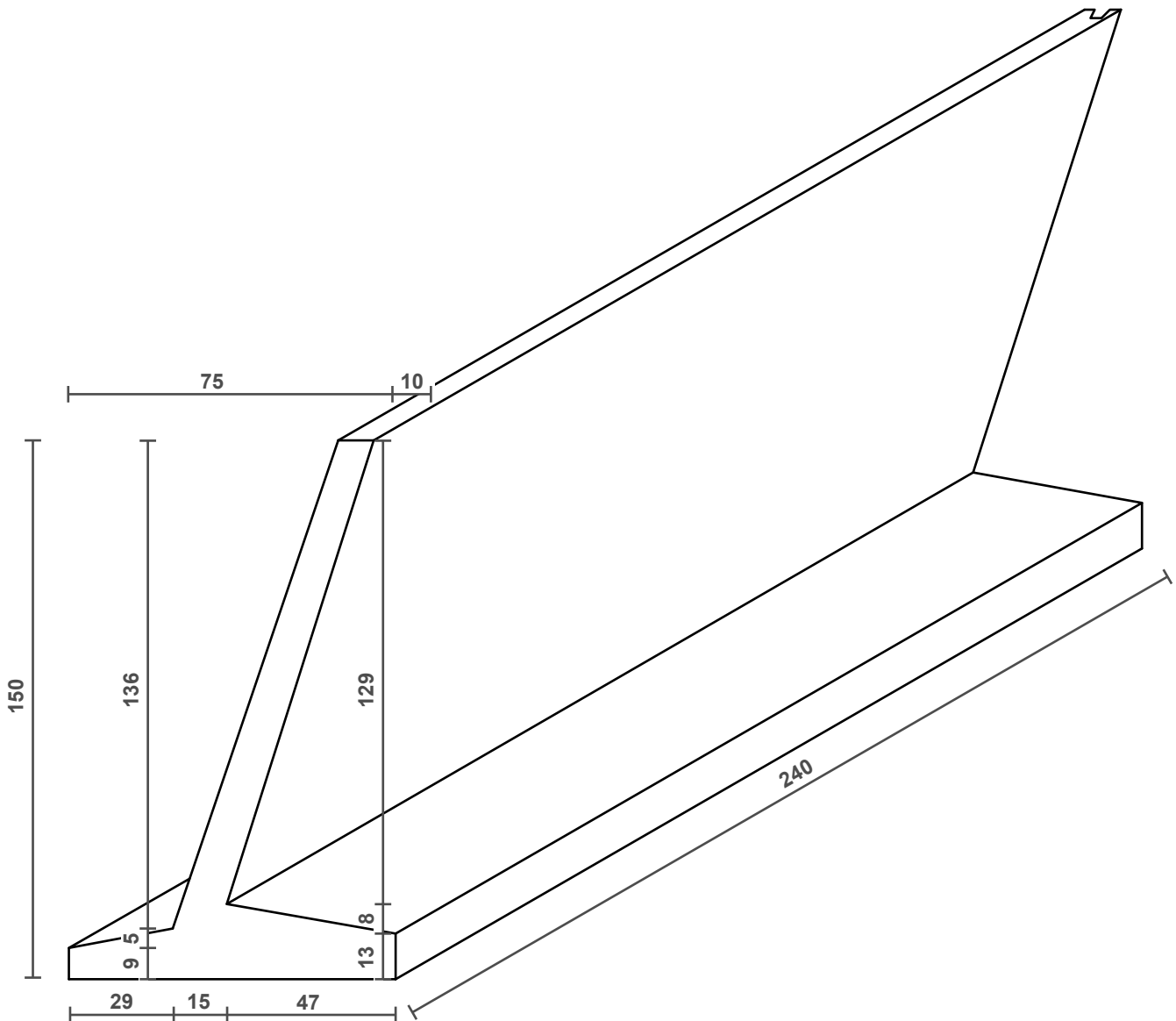

Dimensione elemento
0,91 x 2,40 m H. 1,50 m

Peso elemento
35 q.li