

MURO DI SOSTEGNO T400

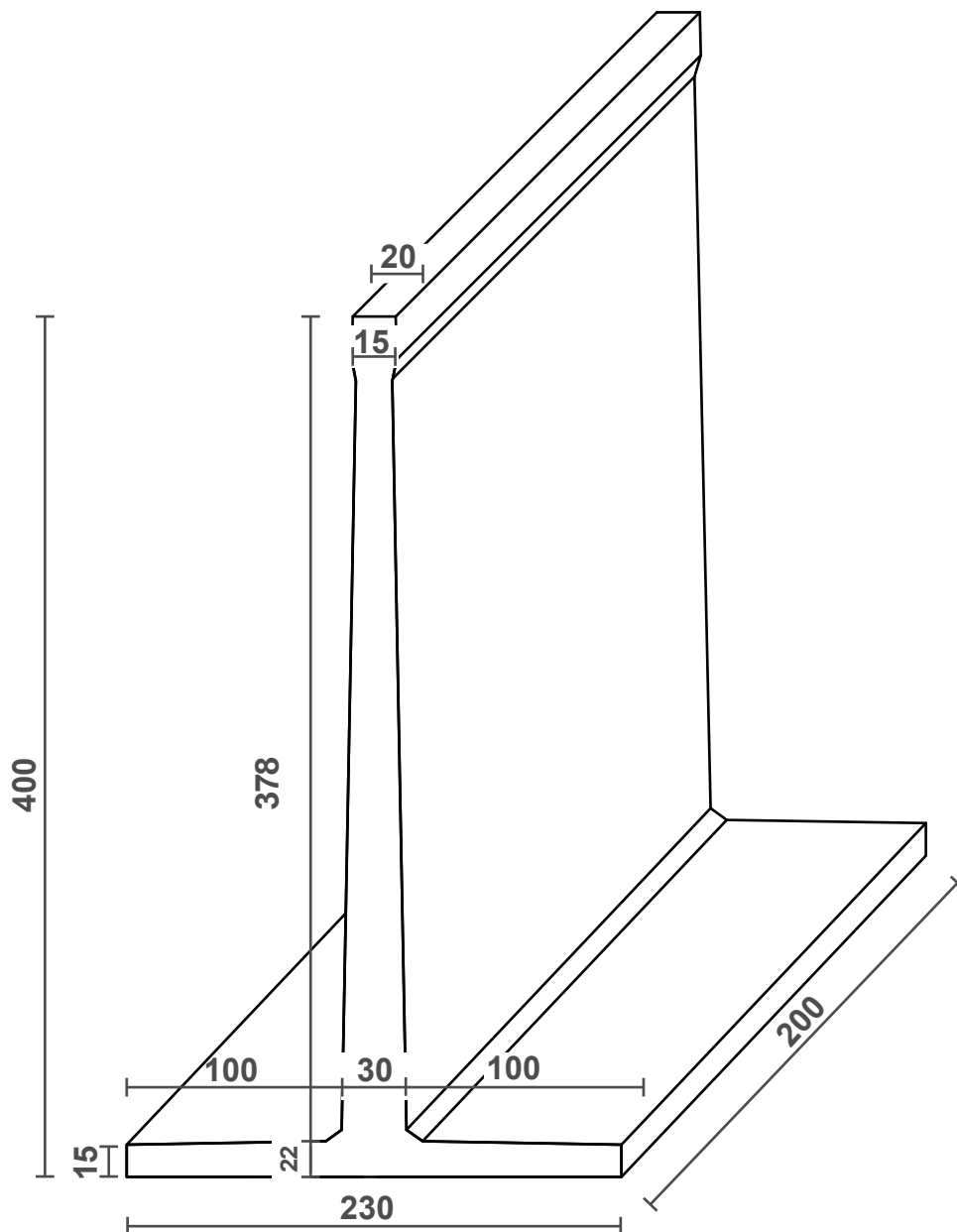

Dimensione elemento
2,30 x 2,00 m H. 4,00 m

Peso elemento
65 q.li