

MURO DI SOSTEGNO T300

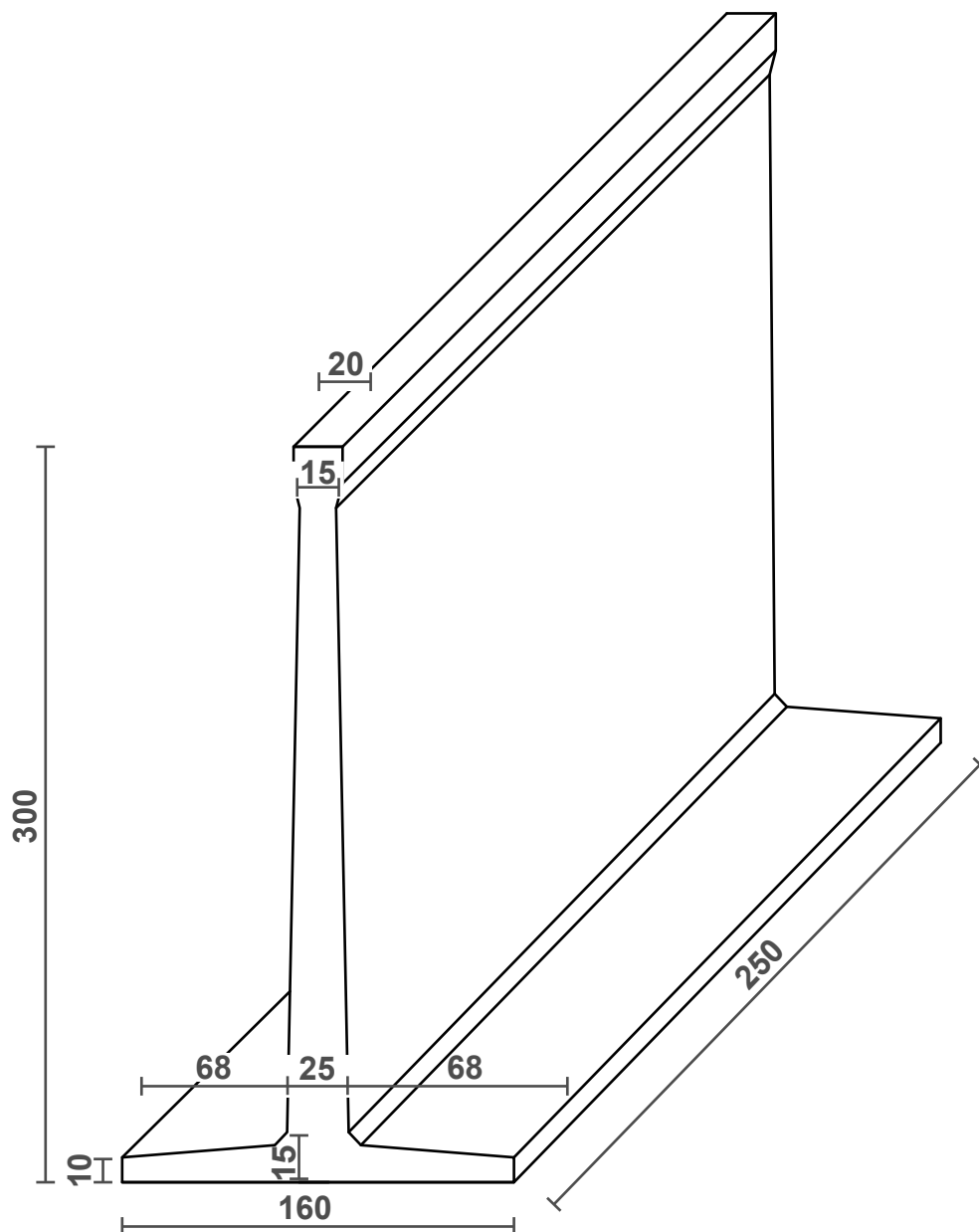

Dimensione elemento
1,60 x 2,50 m H. 3,00 m

Peso elemento
45 q.li