

MURO DI SOSTEGNO V500

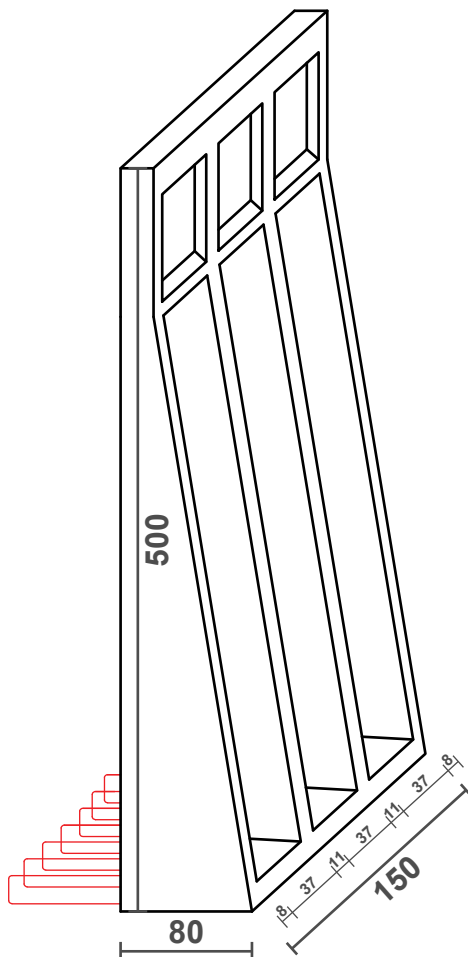

Dimensione elemento
0,80x1,50m H.5,00m

Peso elemento
40 q.li