

MURO DI SOSTEGNO V400

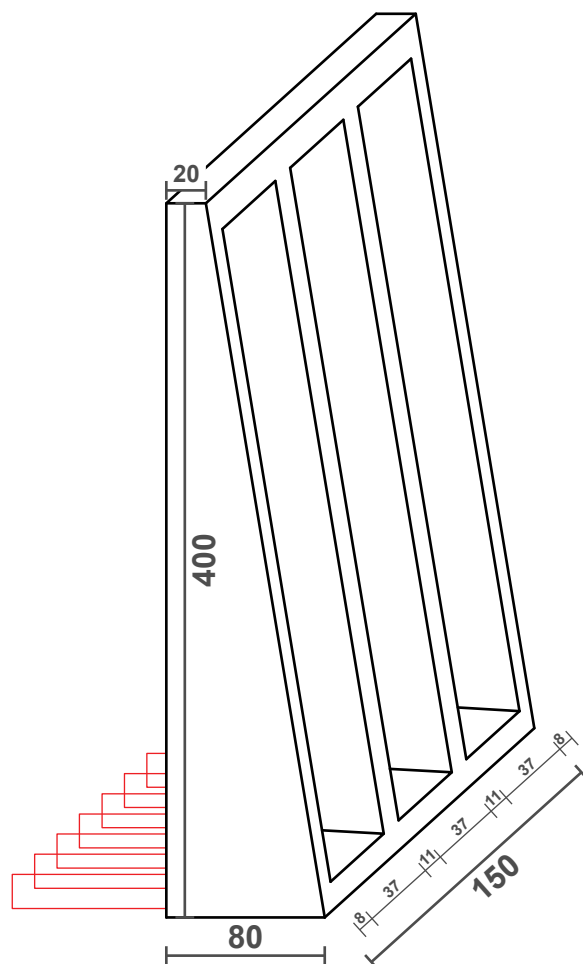

Dimensione elemento
0,80x1,50m H.4,00m

Peso elemento
35 q.li